

P/N: FAUI481768

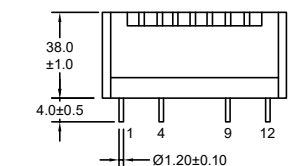

Outline Dimensions(Unit:mm)



Side View

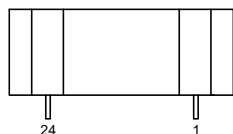

Front View

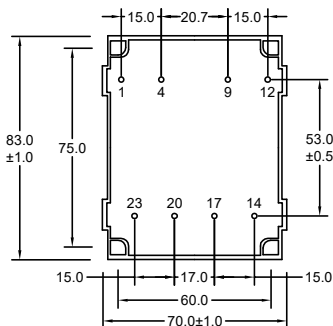

Bottom View

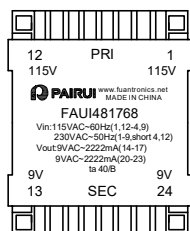

Top View

Note:

- 1.Remove Pins 2,3,5,6,7,8,10,11,13,15,16,18,19,21,22,24.

Wave Soldering

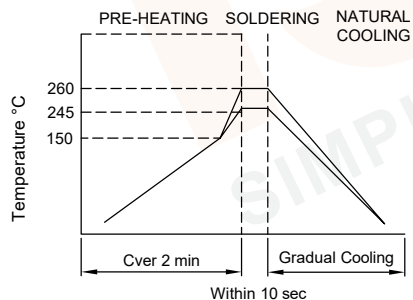

- Note:
- 1.Never Contact the ceramic with the iron tip;
 - 2.1.0mm tip diameter(max).

Electronical Schematic

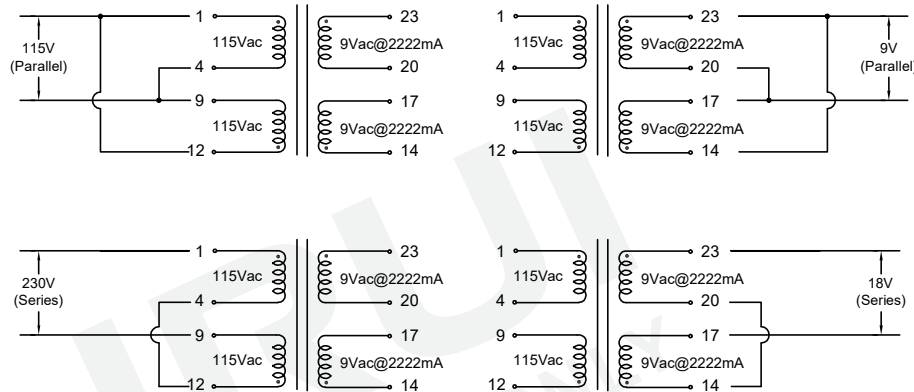

Electrical Characteristics

- Input 115Vac 60Hz to (1,12-4,9)
or 230Vac 50Hz to (1-9,short 4,12) :
- Excitation current(Ix):35mA Max.
- Output: Vo(14-17)=10.0Vac Typ(No-load).
Vo(20-23)=10.0Vac Typ(No-load).
VL(14-17)=9.0Vac±5%(@2222mA).
VL(20-23)=9.0Vac±5%(@2222mA).
- Hi-Pot: Pri-Sec:4000VAC/5mA/60Second.

General Properties

- Operating Temperature:-40°C to +40°C.
Storage Temperature:-25°C to +85°C.
Insulation Class: B.

				Tianchang Fuan Electronic Co Ltd www.fuantronics.net TEL: +86-550-7814888 FAX: +86-550-7831133	 Tolerances unless otherwise specified: (.X)±0.50 (XX)±0.25 Unit of measurement: mm	Make: Qiumei.Liu Checked: Beson. zhan Approved: Anson. zhan	DRAWING TITLE 40.0W Encapsulated Transformer For UI48*17,2*115VAC Input 50/60Hz Material Number: A224817XS010	Customer Name: Document/Rev: Specification Sheet: 1 of 2 Date of Recognition: Jan./02/2020
REV	DESCRIPTION	APPD	DATE					

P/N: FAUI481768

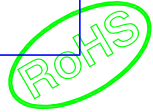

List of UL Certificate:

No.	Part Name	Mat'l Description	Supplier	UL Number
1	Bobbin	UI48*17/PBT(Black)	Chang Chun Plastics Co Ltd	E59481
2	Case	CASE-UI48*17/PBT(Black)	Zhejiang Juner New Materials Co Ltd	E204321
3	Copper wire	2UEW-F/155C	Elektrisola Hangzhou Co Ltd	E258243
4	Core	Lamination	Ta Yea Steel Industry Co Ltd	N/A
5	Epoxy	PU552(Black)	Wevo-Chemle Gmbh	E108835
6				

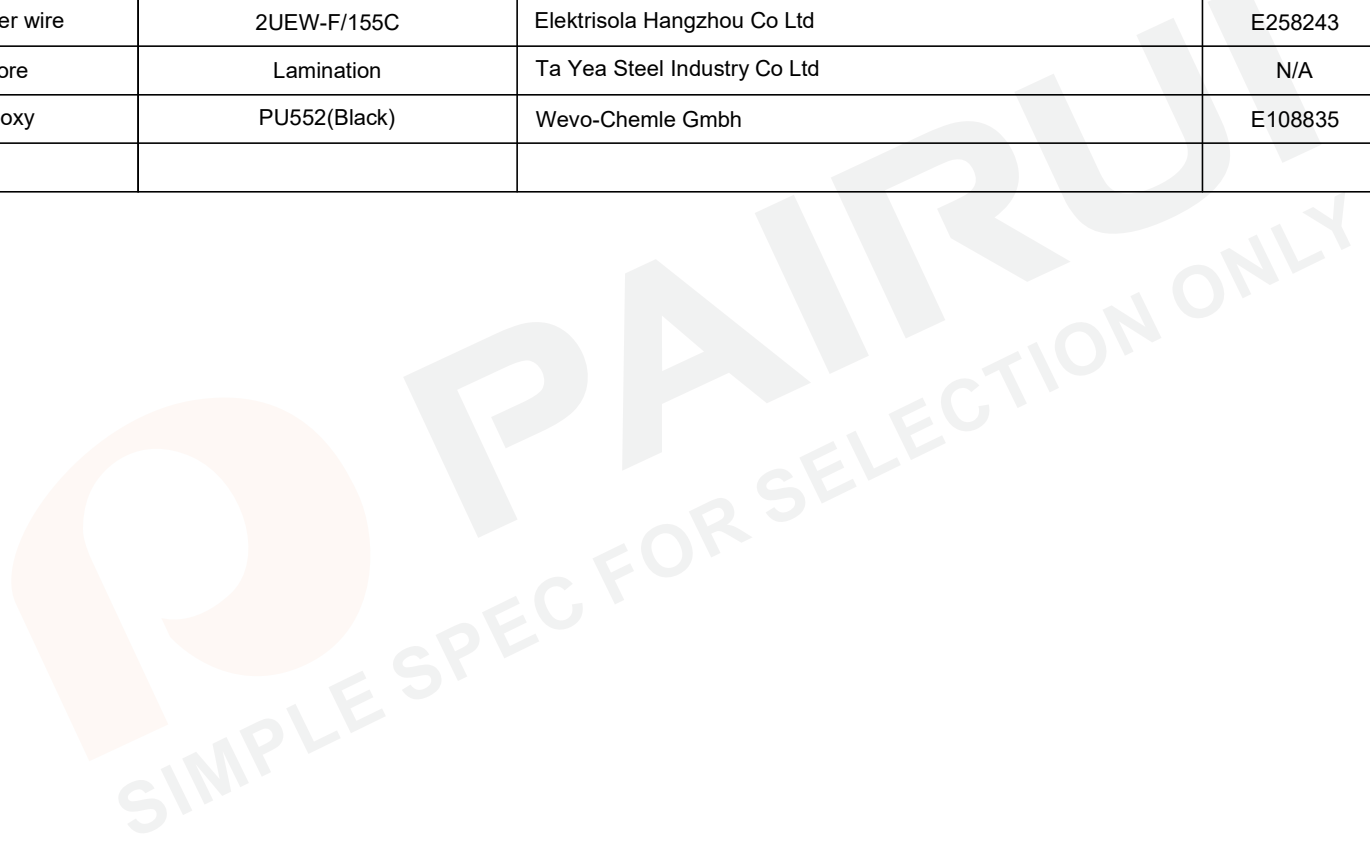

				Tianchang Fuan Electronic Co Ltd www.fuantronics.net TEL: +86-550-7814888 FAX: +86-550-7831133	 Tolerances unless otherwise specified: (.X)±0.50 (XX)±0.25 Unit of measurement: mm	Make: Qiumei.Liu	DRAWING TITLE 40.0W Encapsulated Transformer For UI48*17,2*115VAC Input 50/60Hz	Customer Name:
REV	DESCRIPTION	APPD	DATE			Checked: Beson. zhan		Approved: Anson. zhan